

PATIO HEATER

Instruction Manual

COLORATO

www.colorato.net



For outdoor use only

Uses Propane, Butane or LPG only

Reflector: Dia. 813 mm

Total Height : 2241 mm

Regulator Outlet Pressure: 28-30 mbar (2.8 kPa)

Max. Power: 12 kW

Min. Power: 5 kW

Area of heat coverage: 20 ~ 25 sqm

Please retain this manual for future reference.

CE 0359-16
0359CO1324

TABLE OF CONTENTS

Caution	3
Heater location	4
Gas requirements	5
Leakage test	5
Diagrammatical representations of outdoor areas	6
Parts and Specifications	8
Assembly Parts	9
Assembly procedures	10
Operation	12
Replacing the gas cylinder	13
Storage	13
Cleaning and care	13
General safety	14
First aid for a burn	14
Servicing	15
Solving common problems	15
Problems check list	16



WARNING



- **READ THE INSTRUCTIONS BEFORE USE.**
- This appliance must be installed in accordance with such regulations as are in force.
- This appliance requires installation by a competent person.
- Use only in well-ventilated areas.
- This appliance shall be not used for the heating of domestic premises.
- This appliance shall be used for space heating only.
- This appliance shall not be used in basements or below ground level.
- This appliance has no atmospheric sensing device. It shall be used for heating well-ventilated buildings used for animal rearing, or for outdoor use only.
- This appliance requires approved hose and regulator that are defined under the GAS REQUIREMENTS in the manual, or check with your gas supplier.
- Do not place items on or against this appliance.
- Do not store chemicals or flammable materials or spray aerosols near this appliance.
- Do not operate this appliance in an explosive atmosphere like in areas where gasoline or other flammable liquids or vapors are stored.



WARNING



- Turn off the gas valve immediately if smell of gas is detected.
- Extinguish any open flame.
- If odor continues, contact your gas supplier immediately.



WARNING



The user assumes all risk in the assembly and operation of the gas heater. Failure to follow the warnings and instructions in this manual can result in severe personal injury, death or property damage. If user cannot read or fully understand the instruction manual, please contact your dealer. Supplier will not be responsible for user's negligence.

CAUTION

PLEASE READ CAREFULLY THE FOLLOWING SAFETY GUIDELINES BEFORE OPERATION.

- This patio heater is for outdoor use only (see attached diagrammatical representations of outdoor areas).
- This outdoor heater is not intended to be installed on recreational vehicles and/or boats.
- Do not use the heater for the heating of domestic premises.
- Do not use the heater in the basements or below ground level.
- Gas heater without atmospheric sensing device should only be used for heating well-ventilated buildings used for animal rearing or for outdoor use.
- The installation must conform to appropriate State regulations.
- Installation and repair should be done by a qualified service person.
- Improper installation, adjustment, alteration can cause personal injury or property damage.
- Do not attempt to alter the unit in any manner.
- Never replace or substitute the regulator with any regulator other than the factory-suggested replacement.
- Remove transit protection before use.
- Do not store or use petrol or other flammable vapors or liquids in the heater unit.
- Plumbing tape must be used for all threaded gas connections to prevent leakage.
- The whole gas system, hose, regulator, pilot or burner should be inspected for leaks or damage before use, and at least annually by a qualified service person.
- All leak tests should be done with a soapy water solution. Never use an open flame to check for leaks.
- Do not use the heater until all connections have been leak tested.
- Turn off the gas valve immediately if smell of gas is detected.
- Do not transport the heater while it's operating.
- Do not move the heater after it has been turned off until the temperature has cooled down.
- Keep the ventilation opening of the cylinder enclosure free and clear of debris.
- Do not paint the radiant screen, control panel or top canopy reflector.
- Control compartment, burner and circulation air passageways of the heater must be kept clean. Frequent cleaning may be required as necessary.
- The gas cylinder should be turned off when the heater is not in use.
- Check the heater immediately if any of the following occurs:
 - The heater does not reach temperature.
 - The burner makes popping noise during use (a slight noise is normal when the burner is extinguished).
 - Smell of gas in conjunction with extreme yellow tipping of the burner flames.
- Avoid inhaling fumes emitted from the heater's first use. Smoke and odour from the burning of oils used in manufacturing will appear. Both the smoke and odour will dissipate after approximately 30 minutes.
- The hose assembly must be located out of pathways where people may trip over it or in area where the hose will not be subjected to accidental damage.
- Avoid twisting the flexible tubes and hoses.
- Any guard or other protective device removed for servicing the heater must be replaced before operating the heater.
- Adults and children should stay away from high temperature surfaces to avoid burns or clothing ignition.
- Children should be carefully supervised when they are in the area of the heater.
- Clothing or other flammable materials should not be hung on the heater or placed on or near the heater.

HEATER LOCATION

- The heater is primarily for outdoor use only (see diagrammatical representations of outdoor areas). Do not use it for indoors or in an enclosed area. Always ensure that adequate fresh air ventilation is provided.
- Do not use the heater for the heating of domestic premises.
- Do not use the heater in the basements or below ground level.
- This appliance shall only be used in an above ground open-air situation with natural ventilation, without stagnant areas, where gas leakage and products of combustion are rapidly dispersed by wind and natural convection.
- Any enclosure in which the appliance is used shall comply with one of the following:
 - An enclosure with walls on all sides, but at least one permanent opening at ground level and no overhead cover.
 - Within a partial enclosure that includes an over head cover and no more than two walls.
 - Within a partial enclosure that includes an overhead cover and more than two walls, the following shall apply:
 - At least 25% of the total wall area is completely open, and
 - At least 30% of the remaining wall area is open and unrestricted.
 - In the case of balconies, at least 20% of the total wall area shall be and remain open and unrestricted.
- This appliance shall be used only in an outdoor area and shall not be used in a building, garage or any other enclosed area.
- Always maintain 1.2-m (47") clearance from combustible materials from the top and side.
- Heater must be placed on level firm ground.
- Never operate heater in an explosive atmosphere like in areas where gasoline or other flammable liquids or vapors are stored.
- To protect heater from strong wind, anchor the base securely to the ground with screws.

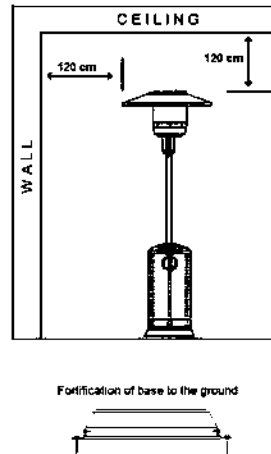

GAS REQUIREMENTS

- Use butane, propane or LPG only.
- The heater is designed for use with 11-13 kg (24-28 lbs.) cylinder. Maximum size of cylinder suitable for the appliance, w/ regulator attached, is Ø31 cm x 64 cm (Ø12" x 25"). Inner dimension of stand within the supporting bars is Ø32 cm x 69 cm (Ø12.6" x 27").
- The appliance requires approved gas hose in 60 cm length and a regulator, or a gas hose in 140 cm length and a regulator if no gas pipe (approx. 84 cm) is used.
- Regulator maximum inlet pressure must not exceed 690 kPa (100 PSI).
- Regulator outlet pressure to be 28 mbar (2.8 kPa or 11" W.C.) to 50 mbar depending to destination country.
- The hose and regulator assembly must conform to local standard codes.
- The installation must conform to local codes, or in the absence of local codes, to the standard for the storage and handling of liquid petroleum gases.
- A dented, rusted or damaged gas cylinder may be hazardous and should be checked by your gas supplier. Never use a gas cylinder with a damaged valve connection.
- The gas cylinder must be arranged to provide for vapor withdrawal from the operating cylinder.
- Avoid twisting the flexible tubes and hoses.
- Never connect an unregulated gas cylinder to the heater.
- Disconnect the gas cylinder when the heater is not use.

LEAKAGE TEST

Gas connections on the heater are leak tested at the factory prior to shipment. A complete gas tightness check must be performed at the installation site due to possible mishandling in shipment or excessive pressure being applied to the heater. The heater must be checked with a full cylinder.

1. Make sure the safety control valve is in the OFF position.
2. Make a soapy water solution of one part liquid detergent and one part water. The soapy water solution can be applied with a spray bottle, brush or rag to all gas connections. Soap bubbles will appear in case of a leak.
3. Turn the gas supply ON.
4. In case of a leak, turn off the gas supply. Tighten any leaking fittings, then turn the gas supply ON and recheck. Contact your dealer or gas supplier for assistance if bubbles continue to appear.

WARNING
Never leak test while smoking.

DIAGRAMMATICAL REPRESENTATIONS OF OUTDOOR AREAS

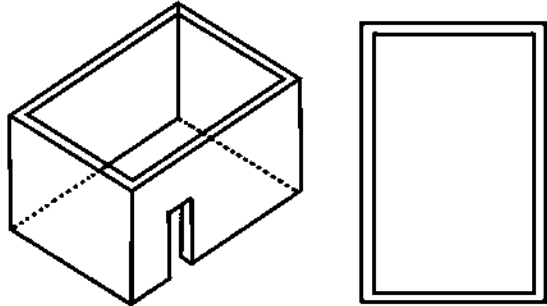

OUTDOOR AREA-EXAMPLE 1

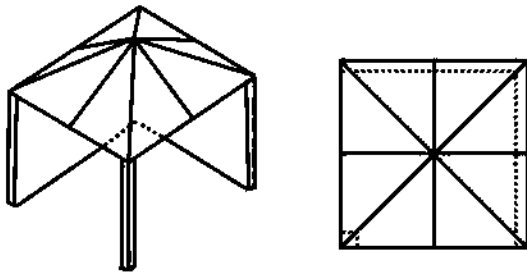

OUTDOOR AREA-EXAMPLE 2

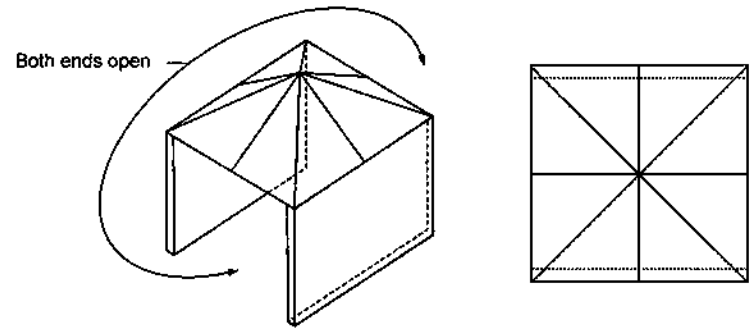

OUTDOOR AREA-EXAMPLE 3

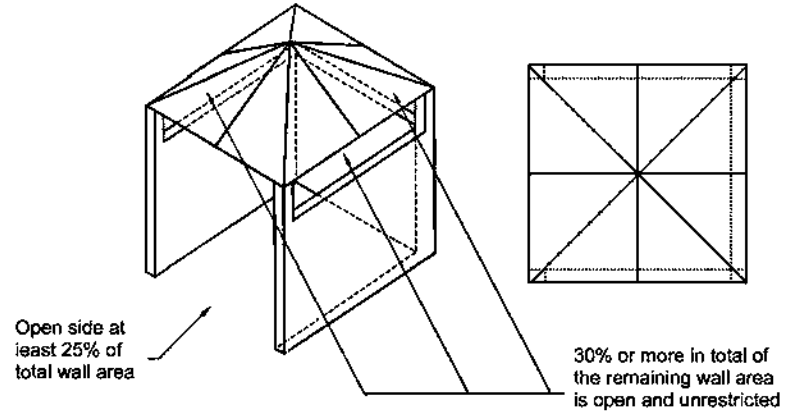

OUTDOOR AREA-EXAMPLE 4

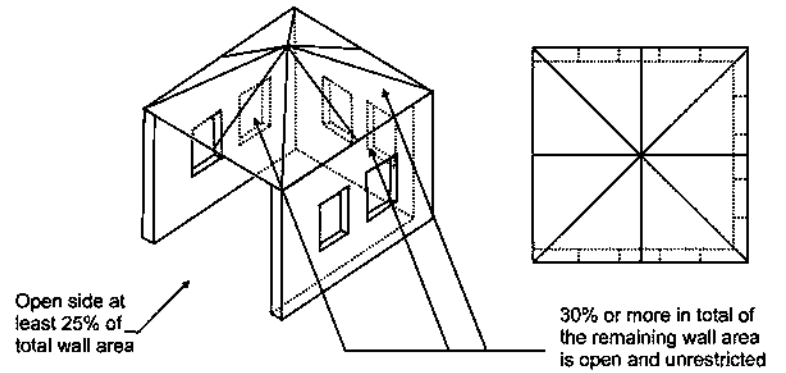

OUTDOOR AREA-EXAMPLE 5

PARTS AND SPECIFICATIONS

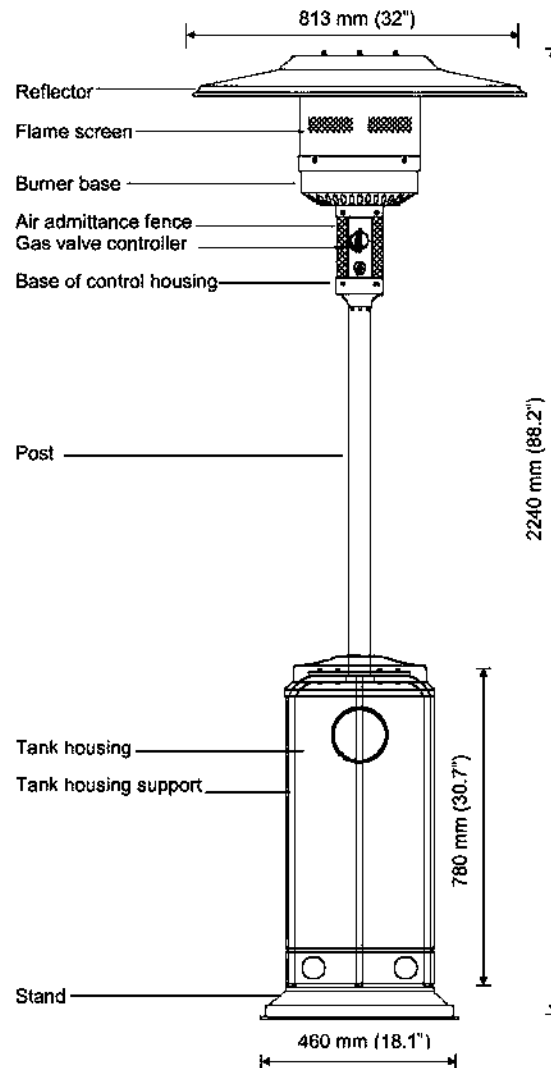

A. Construction and characteristics

- Transportable terrace/garden heater with tank housing
- Stainless steel flame screen
- Heat emission from reflector
- Variable control knob with direct ignition
- Tilt switch shuts off heater automatically when appliance is accidentally knocked down
- USD1,000,000 Product Liability Insurance worldwide

B. Specifications

- For outdoor use only
- Uses butane, propane or LPG only
- Burner pressure: 28/30/37/50 mbar
- Max. wattage: 13 kW
- Min. wattage: 5 kW
- Consumption: 450 g/hr – 870 g/hr
- Weight: Metal w/ powder coating 18 kgs. (39.7 lbs.)
Stainless steel 17 kgs. (38.5 lbs.)
- Height: 2240 mm (88.2")

C. Countries of destination, pressure, and injector openings

Model	HSS MODEL A-A/B/C/D/E/F/G/H/S1/S2/S3			
Countries of Destination	AT, BE, CH, CY, CZ, DE, DK, EE, ES, FI, FR, GB, GR, HU, IE, IS, IT, LT, LU, LV, MT, NL, NO, PL, PT, SE, SI, SK, TR			
Category	I3+	I3 B/P	I3 B/P	I3 B/P
Pressure (mbar)	28-30/37	28-30	30	50
Burner Injector	2.2 mm	2.2 mm	2.2 mm	2.1 mm
Nominal Heat Input	13~14 kW			

ASSEMBLY PARTS

Tools needed:

- Open end wrench 10 & 13 mm
- Adjustable opening wrench (2) 20 cm (8") long
- Slip joint pliers 23 cm (9") long
- Philips screwdriver w/ medium blade
- Plumbing tape for joints
- Spray bottle of soap solution for leakage test

Parts supplied:

- Base
- Tank housing
- Post bracket
- Assembly post
- 10 mm x 84.5 cm (L) galvanized steel pipe + 60 cm gas hose conforming to local standard codes (pressure regulator not included), or 140 cm gas hose only (if no gas pipe is used)
- Burner unit
- Reflector 813 mm with 6 pcs washers Ø8 mm and 3 pcs M8 castle nuts
- 3 pcs 90 mm pins for reflector support
- 4 pcs bolts M6 x 10 mm for assembly post and burner
- 6 pcs bolts & nuts M6 x 35 mm for post and post brackets
- 3 pcs bolts M8 x 16 mm for post brackets and base
- 3 pcs ground fixture kit
- 6 pcs M6 x 10 mm ground fixer bolts & nuts

WARNING

This appliance requires a regulator that is defined under the GAS REQUIREMENTS, or check with your gas supplier.

ASSEMBLY PROCEDURES

STEP 1

- 1-1. Put the 3 pcs post brackets on each position on the base as shown in the picture.
- 1-2. Use 3 pcs M8 x 16 mm bolts to join the post brackets and stand.

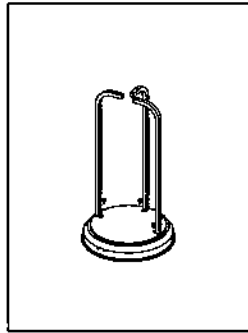

STEP 2

- 2-1. Put the post on the top of 3 pcs post brackets.
- 2-2. Use 6 pcs M6 x 35 mm bolts and nuts to connect the post to the 3 pcs post brackets. Tighten the bolts and nuts.

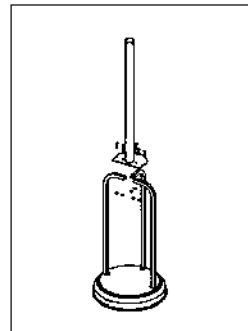

STEP 3

- Place the tank housing on the stand.

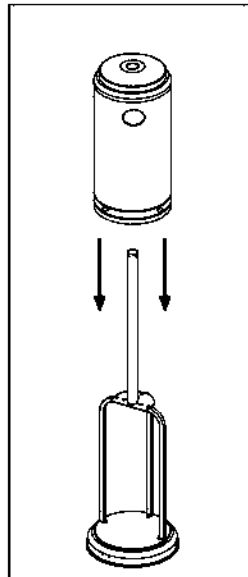

STEP 4

- 4-1. Secure the 3 pcs 90 mm pins (reflector support bolts) on the cap of flame screen.
- 4-2. Connect the gas hose to the tapered end of the gas pipe and secure with metal clamp. (For gas hose with threaded connectors, bind 2 or more rounds of plumbing tape around the gas pipe before connecting the gas hose for security.)
- 4-3. Bind 2 or more rounds of Teflon plumbing tape around the gas burner inlet connector and connect the gas pipe. Use a wrench to tighten the connection.
- 4-4. Fix the completed burner unit to the post by 4 pcs M6 x 10 mm bolts.

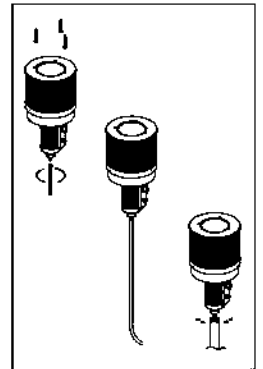

STEP 5

- 5-1. Put Ø8 mm washer on each reflector support bolt.
- 5-2. Fasten the reflector with 3 pcs washers and 3 pcs M8 mm castle nuts.

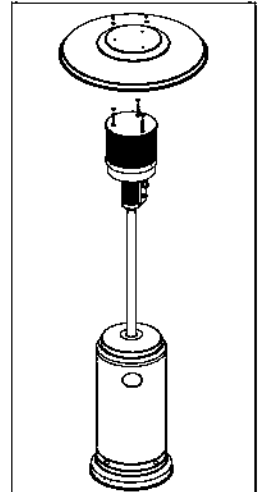

STEP 6

- 6-1. Lift the tank housing and rest it on the post plate.
- 6-2. Connect the other end of gas hose to the regulator and secure with metal clamp. (For gas hose with threaded connectors, bind 2 or more rounds of plumbing tape around the regulator outlet connector before connecting the gas hose for security.)
- 6-3. Connect the regulator to the gas cylinder and tighten it with adjustable wrench.
- 6-4. Put gas cylinder on the stand.

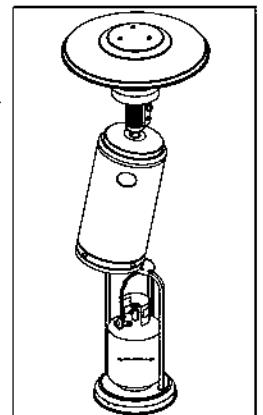

OPERATION

TO TURN ON THE HEATER

1. Turn on the valve on the gas supply cylinder.
2. Press and turn the variable control knob to HI position.
3. Press down the variable control knob and hold for 20 seconds. While holding down the variable control knob, press the igniter button several times until the burner head flame ignites. Release the variable control knob 10 seconds after the ignition.
 - If a new tank has just been connected, please allow at least one minute or more for the air in the gas pipeline to purge out through the pilot hole, or simply do step 3.
 - When lighting the flame make sure that the variable control knob is continuously depressed while pressing the igniter button. Variable control knob can be released after flame lit for 10 seconds.
 - The flame can be watched and checked from the peephole located on the base of the burner.
 - If need small flame, turn the variable control knob to LO position.
4. Turn the variable control knob to LO position for 5 minutes or more before turning the knob to desired temperature setting.
5. If the burner flame goes out accidentally or it is blown out by wind, turn off the heater and wait at least 5 minutes or more to let the gas dissipate before lighting again to avoid possible gas explosion. Repeat steps 2 to 4.

TO TURN OFF THE HEATER

1. Press and turn the control knob to OFF position.
2. Turn off the valve on the gas cylinder and disconnect the cylinder.

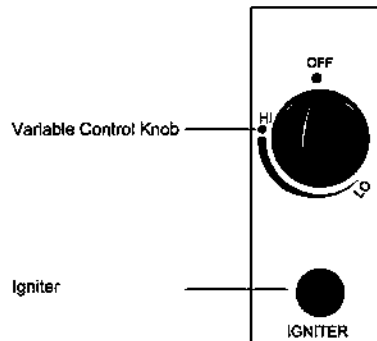

WARNING

1. The whole gas system, hose, regulator, pilot or burner should be inspected for leak before use.
2. Check the hose assembly for sign of extreme abrasion, cuts or wears. Suspected areas should be leak tested. If the hose leaks, it must be replaced with a new one that conforms to local standard codes.
3. Avoid twisting the flexible tubes and hoses.
4. Make sure the ventilation opening of the cylinder enclosure, control compartment, burner and circulation air passageways of the heater are free and clear of debris. If debris, spider or insect nests are found, clean the holes with heavy-duty pipe cleaner or compressed air.
5. Always keep a dry chemical fire extinguisher readily available.
6. For safety, always allow a 5-minute complete shut off period before re-lighting a hot heater.

WARNING

Do not move the heater, or cover it with protective cover after it has been turned off until the temperature has cooled down.

REPLACING THE GAS CYLINDER

1. Close the valve of the gas cylinder.
2. Disconnect the regulator from the cylinder following the instructions that came with your regulator.
3. Replace the cylinder.
4. In the absence of any flame, remove the plug or seal cap from the cylinder valve.
5. Check for the presence and good state of the gasket before connecting the regulator.
6. Perform leak test using soapy water solution.

WARNING

1. Changing of cylinder must be undertaken in a flame-free atmosphere.
2. Make sure that all taps on the consuming appliance are in closed position.

STORAGE

- Always close the valve of the gas cylinder after use or in case of a disturbance.
- Remove the pressure regulator and the hose attachment if the heater is not to be used for a period of time.
- Cylinder must be stored outdoors in a well-ventilated area out of the reach of children.
- Disconnected cylinder must have threaded valve plugs tightly installed and must not be stored in garage or any other enclosed area.
- Storage of heater indoors is permissible only if the cylinder is disconnected and removed from the heater.
- Check the tightness of the gas valve and for damage. If you suspect you have a damaged gas valve, have it changed by your gas dealer.
- Never store liquid gas cylinder in a sub-terrain, or at places without adequate air ventilation.

CLEANING AND CARE

- Wipe off powder coated surfaces with soft, moist rag and soap water. Do not clean heater with cleaners that are combustible or corrosive.
- Remove debris, spider and insect nests from ventilation opening of the cylinder enclosure, control compartment, burner and circulation air passageways of the heater with heavy-duty pipe cleaner or compressed air to keep appliance clean and safe for use. Never clear ports or other openings with toothpicks or other article that will break and block the ports.
- If carbon deposits develop, remove the reflector and flame screen and clean them with soap water. Do not paint the flame screen, control panel or reflector.
- Cover the burner unit with the supplied protective cover when the heater is not in use. Wait until the heater is cool before covering.
- In a salt-air environment, such as near an ocean, corrosion occurs more quickly than normal. Check frequently for corroded areas and repair them promptly.

WARNING

1. Do not perform maintenance after heater has been turned off until the temperature has cooled down.
2. Do not expose the pilot, controllers and parts underneath the burner to water. Do not use the heater if any of these parts are exposed to water until the appliance is inspected or repaired by a qualified service person.

GENERAL SAFETY

- Equip your home with a least one smoke detector on each floor.
- Keep at least one dry-powder operative ABC-type fire extinguisher in the home at all times.
- Keep areas around heat sources free of papers and trash.
- Store paints, solvents, and flammable liquids away from all heat and ignition sources.
- Develop a fire-escape plan before a fire occurs. Be certain every person understands the plan and is able to carry out the plan in case of emergency.
- If your clothing does catch fire don't run. Drop down immediately and roll to smother the flames.

FIRST AID FOR A BURN

EYES

Seek medical attention IMMEDIATELY. Do not put ointments or liquids in eye.

ELSEWHERE

- Consult a doctor if the burn is not healed in 24 hours, or the burn is larger than the size of a palm.
- If serious, send promptly for an ambulance or a doctor.
- If possible, run affected area under cold water, not ice or ice water, for 10-15 minutes if the skin is intact. Cut and gently lift away any clothing covering the burned area, without pulling clothing over the burns. Leave in place any clothing that is stuck to the burns. Do not put any creams or greases on the burned area.
- If the casualty's hands or wrists have been burned remove jewelry if possible without causing further injury (rings, watches, and so forth) and place in his pockets. This prevents the necessity to cut off jewelry since swelling usually occurs as a result of a burn.
- Do not pop any blisters. Cover the burn with a light gauze dressing.
- If blisters pop, apply a light antibiotic ointment and dress as above.

ABNORMAL OPERATION AND TROUBLE SHOOTING

For abnormal operations see problems checklist for problem and solution.

If service is required, contact an authorized or qualified service person to service the appliance.

SERVICING

It is recommended that before using the heater after a period of 3 months or before the start of the heating season the owner should:

- Check the condition of the gas cylinder.
- Check the hose assembly for any wear or damage. If the hose and regulator assembly is damaged or more than 5 years old replace with an approved hose and regulator assembly.
- Check for leaks.

WARNING

Servicing shall be carried out by an authorized or qualified service person only.

If service is required, remove the reflector hood and burner mesh assembly to access the ignition system and gas valve.

Replace the faulty item with correct approved component. Any replacement or accessories are available from your local distributors/dealer.

SOLVING COMMON PROBLEMS

The 3 most common problems associated with any gas heater are gas leaks, wrong gas pressure and dirt.

- **DO NOT USE YOUR HEATER WITHOUT CHECKING FOR LEAKS.** Leaks can occur during shipment and installation. A simple solution of soap and water dabbed on the fittings will bubble if a gas leak is present.
- **WRONG GAS PRESSURE.** Too much gas pressure may severely damage your heater. Too little gas pressure and your heater will not burn correctly. If your installer cannot check gas pressure, call your gas supplier.
- **DUST AND DIRT.** This heater requires some cleaning. Replacement of thermocouple or pilot assembly is generally not needed. Review CLEANING AND CARE in this manual.

PROBLEMS CHECK LIST

<u>PROBLEM</u>	<u>PROBABLE CAUSE</u>	<u>SOLUTION</u>
Burner will not light	<ul style="list-style-type: none"> • Burner injector clogged. • Low gas supply pressure. 	<ul style="list-style-type: none"> • Clean burner injector. • Call your gas supplier.
Burner flame goes off immediately after ignition	<ul style="list-style-type: none"> • Low gas pressure 	<ul style="list-style-type: none"> • Call your gas supplier.
Delayed ignition	<ul style="list-style-type: none"> • Main burner carry over ports clogged. • Low gas supply pressure 	<ul style="list-style-type: none"> • Clean main burner ports. • Call your gas supplier.
Inadequate combustion on burner	<ul style="list-style-type: none"> • Not enough air. 	<ul style="list-style-type: none"> • Check air passageways and burners for dirt and debris, and clean with compressed air.
Burner flame is low	<ul style="list-style-type: none"> • Supply hose is bent or twisted • Blockage in burner injector 	<ul style="list-style-type: none"> • Straighten hose and perform leak test on hose. • Clean or replace burner injector.
Emitter glows uneven	<ul style="list-style-type: none"> • Blockage in burner injector • Base is not on a level surface • Low gas pressure 	<ul style="list-style-type: none"> • Clean or replace burner injector. • Place heater on a level surface. • Replace cylinder with a new cylinder.
Slight smoke and odor during initial operation	<ul style="list-style-type: none"> • Residue from manufacturing processes. 	<ul style="list-style-type: none"> • Will stop after approx. 30 minutes of operation.
Thick black smoke	<ul style="list-style-type: none"> • Blockage in burner 	<ul style="list-style-type: none"> • Turn off the heater and let it cool. Remove blockage and clean burner inside and outside.
Heater produces a whistling noise when burner is lit.	<ul style="list-style-type: none"> • Air passageways blocked. • Air in the gas line. 	<ul style="list-style-type: none"> • Check minimum installation clearances and air passageways for debris. • Operate burner until the air is completely purged.
Heater produces a clicking noise just after burner is lit or turned off.	<ul style="list-style-type: none"> • Metal expanding and contracting, respectively. 	<ul style="list-style-type: none"> • This is common with heaters. If noise is excessive, contact a qualified person.
Gas odor even when control knob is in OFF position	<ul style="list-style-type: none"> • Gas leaks. • Gas control defective. 	<ul style="list-style-type: none"> • Locate and correct leaks immediately. • Replace gas control.

<u>PROBLEM</u>	<u>PROBABLE CAUSE</u>	<u>SOLUTION</u>
Gas odor during combustion	<ul style="list-style-type: none"> • Foreign matter in gas or on burner ports. • Heater burning vapors from paint, impurities in air. • Gas leakage from: <ul style="list-style-type: none"> - Regulator and hose connection. - Valve and pipes connection. - Pipes 	<ul style="list-style-type: none"> • Check gas passageway and burner. • Stop storing and using odor-causing products near the heater. • Locate and correct leaks, or contact your gas supplier.
Carbon build-up	<ul style="list-style-type: none"> • Dirt or film on reflector and flame screen 	<ul style="list-style-type: none"> • Clean reflector and flame screen.